

Indirect Lightning Induced Transient Susceptibility Test System

LSS 160SM6 & LIS 100B



In Compliance With

- > DO-160G S22
- > MIL-STD-461G
- > AECTP 250
- > AECTP 500

Introduction

When an aircraft is flying in severe convection environment, it will be frequently affected by lightning stroke, which will generate transient induced voltage or current on circuits and cables of airborne equipment, such phenomenon is called indirect lightning effect. It may make the aircraft get out of control, even bring about fuselage fire and other serious accidents. For safety reasons, the airborne equipment must be designed properly and tested completely to ensure the system and equipment with critical safety function to perform normally and its flight security when the aircraft is influenced by lightning stroke.

The LSS 160SM6 and LIS 100B test systems are designed according to RTCA/DO-160 Section 22, The LSS 160SM6 is capable of generating waveforms 1,4 and 5A/5B, and LIS 100B is of waveforms 2, 3 and 6. Both test level are from 1 to 3 for pins injection test and cable bundle test; Additionally, the test system is not only meet the test requirement of lightning induced transients conducted susceptibility in MIL-STD-461G CS117.

The test system includes various test auxiliary equipment to make it convenient to conduct tests, such as coupling transformer, power blocking device, transient blocking device, pin injection probe, external DC capacitor etc. What's more, the Corelab software is also available for remote control test, which makes your test easy and convenient.

Features

- > Modular design, the waveform module is detachable;
- > Capable of generating 6 kinds of waveforms and performing pins injection test and cable bundle test;
- > 5.7 inch color touch screen with easy and distinct operation control;
- > Phase synchronization function in signal pins & power pins-direct injection method;
- > Corelab software is available for remote control.

Application Areas

- > Military
- > Aviation

Technical Parameters – LSS 160SM6		
W1		
Coupling Mode	Cable Induction (CI)	Ground Injection (GI)
Module Selection	Wave 1-CI/GI	Wave 1-CI/GI
Current Waveform	6.4 $\mu\text{s} \pm 20\%$ / 69 $\mu\text{s} \pm 20\%$	6.4 $\mu\text{s} \pm 20\%$ / 69 $\mu\text{s} \pm 20\%$
Single-Stroke	25 A – 1000 A +20%, -0%	25 A – 1000 A +20%, -0%
Multiple-Stroke	25 A – 1000 A +20%, -0% (First stroke); 25 A – 500 A +50%, -0% (Subsequent stroke)	25 A – 1000 A +20%, -0% (First stroke); 25 A – 500 A +50%, -0% (Subsequent stroke)
No. of Subsequent Strokes	1 – 14 adjustable	1 – 14 adjustable
Time Intervals of Subsequent Strokes	10 ms – 200 ms adjustable, uniformity mode or random mode	10 ms – 200 ms adjustable, uniformity mode or random mode
Polarity	+, -	+, -
Current Coupling Device	LCVT-L3	LCVT-L3
No. of Tests	1 – 99	1 – 99
Test Repetition	30 s – 99 s (the min. depends on the output amplitude)	30 s – 99 s (the min. depends on the output amplitude)
EUT Load Capacity	/	AC 230 V, 16 A, 50 Hz / 60 Hz, & DC

Technical Parameters –LSS 160SM6		
W4		
Coupling Mode	Cable Induction (CI)	Ground Injection (GI)
Module Selection	Wave 4-CI/GI	Wave 4-CI/GI
Voltage Waveform	6.4 $\mu\text{s} \pm 20\%$ / 69 $\mu\text{s} \pm 20\%$	6.4 $\mu\text{s} \pm 20\%$ / 69 $\mu\text{s} \pm 20\%$
Single-Stroke	10 V – 1,700 V +20%, -0%	10 V – 1,700 V +20%, -0%
Multiple-Stroke	10 V – 1,700 V +20%, -0% (First stroke); 10 V – 500 V +50%, -0% (Subsequent stroke)	10 V – 1,700 V +20%, -0% (First stroke); 10 V – 500 V +50%, -0% (Subsequent stroke)
No. of Subsequent Strokes	1 – 14 adjustable	1 – 14 adjustable
Time Intervals of Subsequent Strokes	10 ms – 200 ms adjustable, uniformity mode or random mode	10 ms – 200 ms adjustable, uniformity mode or random mode
Polarity	+, -	+, -
Voltage Coupling Device	LCVT-L3	LCVT-L3
No. of Tests	1 – 99	1 – 99
Test Repetition	10 s – 99 s (the min. depends on the output amplitude)	10 s – 99 s (the min. depends on the output amplitude)
EUT Load Capacity	/	AC 230 V, 16 A, 50 Hz / 60 Hz, & DC

Technical Parameters – LSS 160SM6	
W4	
Coupling Mode	Pin Injection (PI)
Module Selection	Wave 4-PI
Output Impedance	5 Ω \pm 10%
Voltage/Current Waveform	6.4 μ s \pm 20% / 69 μ s \pm 20%
Single-Stroke	25 V – 800 V +10%, -0% (open-circuit voltage); 5 A – 160 A +10%, -0% (short-circuit current);
Polarity	+, -
No. of Tests	1 - 99
Test Repetition	10 s – 99 s (the min. depends on the output amplitude)
EUT Power Sync	Synchronized automatically with AC power peak value or 0°~359° (resolution 1°, tolerance less than 10°)
EUT Load Capacity	AC 230 V, 800 Hz

Technical Parameters – LSS 160SM6		
W5A		
Coupling Mode	Cable Induction (CI)	Ground Injection (GI)
Module Selection	Wave 5A-CI/GI	Wave 5A-CI/GI
Current Waveform	40 μ s \pm 20% / 120 μ s \pm 20%	40 μ s \pm 20% / 120 μ s \pm 20%
Single-Stroke	20 A – 2,000 A +20%, -0%	20 A – 2,000 A +20%, -0%
Multiple-Stroke	20 A – 2,000 A +20%, -0% (First stroke); 20 A – 1000 A +50%, -0% (Subsequent stroke)	20 A – 2,000 A +20%, -0% (First stroke); 20 A – 1000 A +50%, -0% (Subsequent stroke)
No. of Subsequent Strokes	1 – 14 adjustable	1 – 14 adjustable
Time Intervals of Subsequent Strokes	10 ms – 200 ms adjustable, uniformity mode or random mode	10 ms – 200 ms adjustable, uniformity mode or random mode
Polarity	+, -	+, -
Current Coupling Device	LCVT-L3	LCVT-L3
No. of Tests	1 – 99	1 – 99
Test Repetition	30 s – 99 s (the min. depends on the output amplitude)	30 s – 99 s (the min. depends on the output amplitude)
EUT Load Capacity	/	AC 230 V, 16 A, 50 Hz / 60 Hz, & DC

Technical Parameters – LSS 160SM6		
W5B		
Coupling Mode	Cable Induction (CI)	Ground Injection (GI)
Module Selection	Wave 5B-CI/GI	Wave 5B-CI/GI
Current Waveform	50 μ s \pm 20% / 500 μ s \pm 20%	50 μ s \pm 20% / 500 μ s \pm 20%
Single-Stroke	25 A – 2,000 A +20%, -0%	25 A – 2,000 A +20%, -0%
Multiple-Stroke	25 A – 2,000 A +20%, -0% (First stroke); 25 A – 1000 A +50%, -0% (Subsequent stroke)	25 A – 2,000 A +20%, -0% (First stroke); 25 A – 1000 A +50%, -0% (Subsequent stroke)
No. of Subsequent Strokes	1 – 14 adjustable	1 – 14 adjustable
Time Intervals of Subsequent Strokes	30 ms – 200 ms adjustable, uniformity mode or random mode	30 ms – 200 ms adjustable, uniformity mode or random mode
Polarity	+, -	+, -
Current Coupling Device	LCVT-L3	LCVT-L3
No. of Tests	1 – 99	1 – 99
Test Repetition	30 s – 99 s (the min. depends on the output amplitude)	30 s – 99 s (the min. depends on the output amplitude)
EUT Load Capacity	/	AC 230 V, 16 A, 50 Hz / 60 Hz, & DC

Technical Parameters – LSS 160SM6	
W5A	
Coupling Mode	Pin Injection (PI)
Module Selection	Wave 5A-PI
Output Impedance	1 Ω \pm 10%
Voltage/Current Waveform	40 μ s \pm 20% / 120 μ s \pm 20%
Single-Stroke	25 V – 800 V +10%, -0% (open-circuit voltage); 25 A – 800 A +10%, -0% (short-circuit current);
Polarity	+, -
No. of Tests	1 - 99
Test Repetition	30 s – 99 s (the min. depends on the output amplitude)
EUT Power Sync	Synchronized automatically with AC power peak value or 0°~359° (resolution 1°, tolerance less than 10°)
EUT Load Capacity	AC 230 V, 800 Hz

Technical Parameters – LSS 160SM6	
W5B	
Coupling Mode	Pin Injection (PI)
Module Selection	Wave 5B-PI
Output Impedance	1 Ω \pm 10%
Voltage/Current Waveform	50 μ s \pm 20% / 500 μ s \pm 20%
Single-Stroke	25 V – 800 V +10%, -0% (open-circuit voltage); 25 A – 800 A +10%, -0% (short-circuit current);
Polarity	+, -
No. of Tests	1 - 99
Test Repetition	30 s – 99 s (the min. depends on the output amplitude)
EUT Power Sync	Synchronized automatically with AC power peak value or 0°~359° (resolution 1°, tolerance less than 10°)
EUT Load Capacity	AC 230 V, 800 Hz

Technical Parameters – LIS 100B	
W2	
Coupling Mode	Cable Induction (CI)
Rise Time	< 100 ns
Duration	6.4 μ s \pm 20%
Single-Stroke	25 V – 1,600 V +20%, -0%
Multiple-Stroke	25 V – 750 V +20%, -0% (First stroke); 12.5 V – 350 V +50%, -0% (Subsequent Stroke)
Test Repetition	1.5 s – 60 s (the min. depends on the output amplitude)
Polarity	+, -
High-Frequency Voltage Coupling Transformer	LVT-2





Technical Parameters – LIS 100B	
W3	
Coupling Mode	Pin Injection (PI)
Module Selection	W3 – 1 MHz
Output Impedance	25 Ω
Voltage/Current Repetition	1 MHz \pm 20%
Attenuation of 5th Stroke	25% - 75%
Single-Stroke	50 V – 2000 V +10%, -0%; 2 A – 80 A +10%, -0% (short-circuit current)
Test Repetition	1.5 s – 60 s (the min. depends on the output amplitude)
Polarity	+, -
Phase Sync.	0° - 359°, 1° step
EUT Load Capacity	AC 230 V, DC \pm 50 V, 800 Hz







Technical Parameters – LIS 100B		
W3		
Coupling Mode	Cable Induction (CI)	Cable Induction (CI)
Module Selection	W3 – 1 MHz	W3 – 10 MHz
Voltage/Current Repetition	1 MHz \pm 20%	10 MHz \pm 20%
Attenuation of 5th Stroke	25% - 75%	25% - 75%
Single-Stroke	50 V – 2000 V +20%, -0%	50 V – 1600 V +20%, -0%
Multiple-Stroke	50 V – 2000 V +20%, -0% (First stroke); 25 V – 1000 V +50%, -0% (Subsequent stroke)	50 V – 1600 V +20%, -0% (First stroke); 25 V – 800 V +50%, -0% (Subsequent stroke)
Multiple-Burst	50 V – 900 V +20%, -0%	50 V – 900 V +20%, -0%
Test Repetition	1.5 s – 60 s (the min. depends on the output amplitude)	1.5 s – 60 s (the min. depends on the output amplitude)
Polarity	+, -	+, -
High-Frequency Voltage Coupling Transformer	LVT-2	LVT-2





Technical Parameters – LIS 100B	
W6	
Coupling Mode	Cable Induction (CI)
Current Waveform	5 A-75 A
Rise Time	0.25 μ s \pm 20%
Pulse Width	4 μ s \pm 20%
Test Repetition	3 s-10 s (the min. depends on the output amplitude)
High-Frequency Voltage Coupling Transformer	LVT-3

General Parameters	
Power Supply Voltage	AC 110 V / 220 V \pm 10%, 50 Hz / 60 Hz \pm 5% (Default AC 220 V 50 Hz in mainland China)
Max Power	200 W
Operating Temp.	15 °C - 35 °C
Operating Humidity	45% - 75%
Operating Air Pressure	86 kPa – 106 kPa

Standard Accessories
Testing Wire, Fuse *2 (spare part), User Manual, Power Wire, Coaxial Cable, Plug Clip

Options (LSS 160SM6)	
<p>1. Line Impedance Stabilization Network LISN AR 50</p> 	<p>The LISN AR 50 is used for isolating electric wave in cable bundle test and supply stable impedance for test system; Max AC 530 V, DC 600 V I rms: 50 A; Frequency Range: 10 kHz ~ 400 MHz</p>
<p>2. Coupling Transformer LCVT-L3</p> 	<p>Used for coupling current waveforms of W1, W5A, and W5B; Used for W4 voltage waveform coupling; Can meet the single and multiple rebound tests of cable bundles W1, W5A, W5B current waveforms and W4 voltage waveforms</p>
<p>3. External DC Capacitor C3350/C33400</p> 	<p>The C3350/C33400 is used together with LISN for conducting cable bundle tests; Maximum DC voltage is 400 V (general configuration is 50 V); Capacitance: 33000 μF</p>
<p>4. Power Blocking Device CN-1</p> 	<p>The CN-1 is used to isolate voltages at the pins of the EUT from the low generator impedance so as to protect the generator; The maximum isolating ac/dc voltage is 400 V; Meet the test requirement of powered EUT for conducting pins injection test of waveforms 4, 5A, 5B</p>
<p>5. Transient Blocking Device DN-416T</p> 	<p>The DN-416T is used to prevent EUT power supply from being damaged by pulses 4, 5A and 5B; EUT Maximum ac/dc power supply is 400 V 16 A three-phase, 0 ~ 400 Hz (common mode); Meet the test requirement of powered EUT for conducting pins injection test of waveforms 4, 5A, 5B</p>

Options (LIS 100B)	
<p>6. Coupling Transformer LVT-2</p> 	<p>The LVT-2 is used to couple voltage of waveform 2 and waveform 3 (1 MHz & 10 MHz); It satisfies single stroke, multiple stroke and multiple burst tests of cable bundle; Test level is from 1 to 3; Max. coupling voltage is 2000 V for W2; Max. coupling voltage is 4000 V for W3</p>
<p>7. Coupling Transformer LVT-3</p> 	<p>The LVT-3 is used to couple current of waveform 6; It satisfies multiple burst tests of cable bundle; Test level is from 1 to 3; Max. coupling current is 160 A</p>
<p>8. Power Blocking Device CN-2</p> 	<p>The CN-2 is used to isolate voltages at the pins of the EUT from the low generator impedance in waveform 3 pins direct injection test</p>
<p>9. Handheld Pin Injection Probe HIP 5000</p> 	<p>The probe is used in pin injection tests of waveform 3 (1 MHz); Handheld structure design makes pin injection tests convenient</p>
<p>10. Current Divider MCS 01</p> 	<p>The MCS 01 is used to measure current of waveforms 2, 3 and 6</p>
<p>11. 35U rack ETS 160MB-35U</p> 	<p>The 35U rack is used to place all devices and accessories to makes the storage in order; There are two main unit storage tanks and four waveform input modules storage tanks, and each tank having sliding rail, which makes it easy to insert or pull out the modules</p>

Options (Measurements)	
12. Digital Oscilloscope MDO3012 (Tektronix) 	Frequency 100 MHz; Sample Rate 1.25 GS/s; Record length 10 Mb
13. Wide-band Current Monitor CM 0220M 	Max. peak current 20 kA; Sensitivity 0.01 V/A; Current time product: 1 A · s
14. Wide-band Current Monitor CM 0302M 	Max. peak current 200 kA; Sensitivity 0.001 V/A; Current time product: 10 A · s
15. Differential Probe THDP0100 (Tektronix) 	6 kV differential mode, 100 MHz; The THDP0100 is used for measuring voltage of all waveforms

Control Software	
Corelab	The software is used for remote control; Support connection with oscilloscope for monitoring waveforms; Support generating test report.

1、 Calibration diagram :

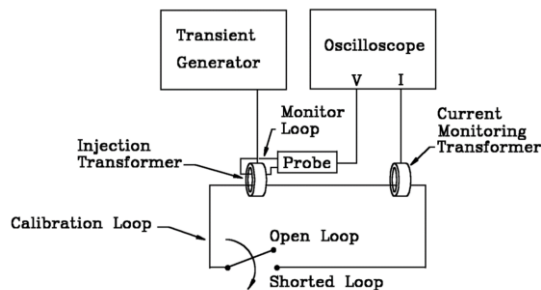

2、 Test diagram :

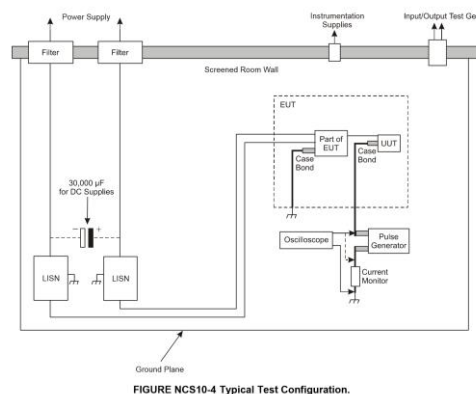

FIGURE NCS10-4 Typical Test Configuration.



SUZHOU 3CTEST ELECTRONIC CO., LTD.

Add.: No. 99 E'meishan Road, SND, Suzhou, Jiangsu Province, China

Tel: +86 (0)512 6807 7192 Fax: +86-512-68079795

Sales Email: globalsales@3ctest.cn Service Email: service@3ctest.cn

www.3c-test.com