



RIGOL

MHO/DHO5000 Series

Digital Oscilloscope

Quick Guide

Oct. 2024

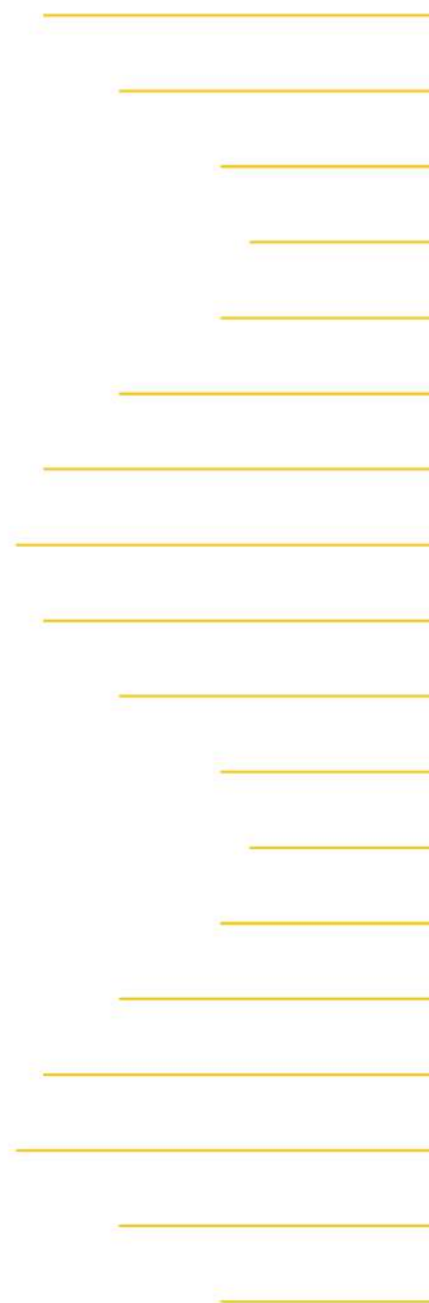

Guaranty and Declaration

Copyright

© 2024 RIGOL TECHNOLOGIES CO., LTD. All Rights Reserved.

Trademark Information

RIGOL® is the trademark of RIGOL TECHNOLOGIES CO., LTD.

Software Version

Software upgrade might change or add product features. Please acquire the latest software version from **RIGOL** website or contact **RIGOL** to upgrade the software.

Notices

- RIGOL products are covered by P.R.C. and foreign patents, issued and pending.
- RIGOL reserves the right to modify or change parts of or all the specifications and pricing policies at the company's sole decision.
- Information in this publication replaces all previously released materials.
- Information in this publication is subject to change without notice.
- RIGOL shall not be liable for either incidental or consequential losses in connection with the furnishing, use, or performance of this manual, as well as any information contained.
- Any part of this document is forbidden to be copied, photocopied, or rearranged without prior written approval of RIGOL.

Product Certification

RIGOL guarantees that this product conforms to the national and industrial standards in China as well as the ISO9001:2015 standard and the ISO14001:2015 standard. Other international standard conformance certifications are in progress.

Contact Us

If you have any problem or requirement when using our products or this manual, please contact RIGOL.

E-mail: service@rigol.com

Website: <http://www.rigol.com>

1 Safety Requirement

1.1 General Safety Summary

Please review the following safety precautions carefully before putting the instrument into operation so as to avoid any personal injury or damage to the instrument and any product connected to it. To prevent potential hazards, please follow the instructions specified in this manual to use the instrument properly.

- | | | | |
|---|--|----|--|
| 1 | Only the exclusive power cord designed for the instrument and authorized for use within the destination country could be used. | 9 | Do not operate the instrument with suspected failures. |
| 2 | Ensure that the instrument is safely grounded. | 10 | Provide adequate ventilation. |
| 3 | Observe all terminal ratings. | 11 | Do not operate in wet conditions. |
| 4 | Use proper overvoltage protection. | 12 | Do not operate in an explosive atmosphere. |
| 5 | Do not operate without covers. | 13 | Keep instrument surfaces clean and dry. |
| 6 | Do not insert objects into the air outlet. | 14 | Prevent electrostatic impact. |
| 7 | Use the proper fuse. | 15 | Handle with caution. |
| 8 | Avoid circuit or wire exposure. | | |



WARNING

Equipment meeting Class A requirements may not offer adequate protection to broadcast services within residential environment.

1.2 Safety Notices and Symbols

Safety Notices in this Manual:



WARNING

Indicates a potentially hazardous situation or practice which, if not avoided, will result in serious injury or death.



CAUTION

Indicates a potentially hazardous situation or practice which, if not avoided, could result in damage to the product or loss of important data.

Safety Notices on the Product:

- **DANGER**

It calls attention to an operation, if not correctly performed, could result in injury or hazard immediately.

- **WARNING**

It calls attention to an operation, if not correctly performed, could result in potential injury or hazard.

- **CAUTION**

It calls attention to an operation, if not correctly performed, could result in damage to the product or other devices connected to the product.

Safety Symbols on the Product:

Hazardous Voltage



Safety Warning



Protective Earth Terminal

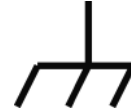

Chassis Ground

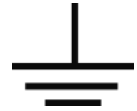

Test Ground

1.3 Measurement Category

Measurement Category

This instrument can make measurements in Measurement Category I.

**WARNING**

This instrument can only be used for measurements within its specified measurement categories.

Measurement Category Definitions

- **Measurement category I** is for measurements performed on circuits not directly connected to MAINS. Examples are measurements on circuits not derived from MAINS, and specially protected (internal) MAINS derived circuits. In the latter case, transient stresses are variable. Thus, you must know the transient withstand capability of the equipment.
- **Measurement category II** is for measurements performed on circuits directly connected to low voltage installation. Examples are measurements on household appliances, portable tools and similar equipment.
- **Measurement category III** is for measurements performed in the building installation. Examples are measurements on distribution boards, circuit-breakers, wiring (including cables, bus-bars, junction boxes, switches and socket-outlets) in the fixed installation, and equipment for industrial use and some other

equipment. For example, stationary motors with permanent connection to a fixed installation.

- **Measurement category IV** is for measurements performed at the source of a low-voltage installation. Examples are electricity meters and measurements on primary overcurrent protection devices and ripple control units.

1.4 Ventilation Requirement

This instrument uses a fan to force cooling. Please make sure that the air inlet and outlet areas are free from obstructions and have free air. When using the instrument in a bench-top or rack setting, provide at least 10 cm clearance beside, above and behind the instrument for adequate ventilation.



CAUTION

Inadequate ventilation may cause an increase of temperature in the instrument, which would cause damage to the instrument. So please keep the instrument well ventilated and inspect the air outlet and the fan regularly.

1.5 Working Environment

Temperature

Operating: 0°C to +50°C

Non-operating: -30°C to +60°C

Humidity

- **Operating:**
 - Below +30°C: $\leq 90\%RH$ (without condensation)
 - +30°C to +40°C: $\leq 75\% RH$ (without condensation)
 - +40°C to +50°C: $\leq 45\%RH$ (without condensation)
- **Non-operating:**
 - Below +60°C: $\leq 90\%RH$ (without condensation)



WARNING

To avoid short circuit inside the instrument or electric shock, never operate the instrument in a humid environment.

Altitude

- **Operating:** below 3 km
- **Non-operating:** below 15 km

Protection Level Against Electric Shock

ESD $\pm 8\text{kV}$

Installation (Overvoltage) Category

This product is powered by mains conforming to installation (overvoltage) category II.



WARNING

Ensure that no overvoltage (such as that caused by a bolt of lightning) can reach the product. Otherwise, the operator might be exposed to the danger of an electric shock.

Installation (Overvoltage) Category Definitions

Installation (overvoltage) category I refers to signal level which is applicable to equipment measurement terminals connected to the source circuit. Among these terminals, precautions are done to limit the transient voltage to a low level.

Installation (overvoltage) category II refers to the local power distribution level which is applicable to equipment connected to the AC line (AC power).

Pollution Degree

Pollution Degree 2

Pollution Degree Definition

- **Pollution Degree 1:** No pollution or only dry, nonconductive pollution occurs. The pollution has no effect. For example, a clean room or air-conditioned office environment.
- **Pollution Degree 2:** Normally only nonconductive pollution occurs. Temporary conductivity caused by condensation is to be expected. For example, indoor environment.
- **Pollution Degree 3:** Conductive pollution or dry nonconductive pollution that becomes conductive due to condensation occurs. To be found in industrial environment or construction sites (harsh environments). For example, sheltered outdoor environment.
- **Pollution Degree 4:** The pollution generates persistent conductivity caused by conductive dust, rain, or snow. For example, outdoor areas.

Safety Class

Class 2

1.6 Care and Cleaning

Care

Do not store or leave the instrument where it may be exposed to direct sunlight for long periods of time.

Cleaning

Clean the instrument regularly according to its operating conditions.

1. Disconnect the instrument from all power sources.
2. Clean the external surfaces of the instrument with a soft cloth dampened with mild detergent or water. Avoid having any water or other objects into the chassis via the heat dissipation hole. When cleaning the LCD, take care to avoid scarifying it.



CAUTION

To avoid damage to the instrument, do not expose it to caustic liquids.



WARNING

To avoid short-circuit resulting from moisture or personal injuries, ensure that the instrument is completely dry before connecting it to the power supply.

1.7 Environmental Considerations

The following symbol indicates that this product complies with the WEEE Directive 2012/19/EU.



The equipment may contain substances that could be harmful to the environment or human health. To avoid the release of such substances into the environment and avoid harm to human health, we recommend you to recycle this product appropriately to ensure that most materials are reused or recycled properly. Please contact your local authorities for disposal or recycling information.

You can click on the following link <https://int.rigol.com/services/services/declaration> to download the latest version of the RoHS&WEEE certification file.

2 Document Overview

This manual gives you a quick overview of the front and rear panel, user interface as well as basic operation methods of MHO/DHO5000 series.



TIP

For the latest version of this manual, download it from the official website of RIGOL (<http://www.rigol.com>).

Publication Number

QGA43100-1110

Software Version

Software upgrade might change or add product features. Please acquire the latest version of the manual from RIGOL website or contact RIGOL to upgrade the software.

Format Conventions in this Manual

1. Key

The front panel key is denoted by the menu key icon. For example,  indicates the "DEFAULT" key.

2. Menu

The menu item is denoted by the format of "Menu Name (Bold) + Character Shading" in the manual. For example, **Setup** indicates the "Setup" sub-menu under the "Utility" function menu. You can click or tap **Setup** to access the "Setup" menu.

3. Operation Procedures

The next step of the operation is denoted by ">" in the manual. For example, 

> **Storage** indicates first clicking or tapping  and then clicking or tapping **Storage**.

4. The front/rear panel connector is denoted by "Brackets + Connector Name (Bold)", for example, [**AUX OUT**].

Content Conventions in this Manual

MHO/DHO5000 series digital oscilloscope includes the following models, which support different combinations of features.

Model	Max. Analog Bandwidth	Analog Channels	Function/ Arbitrary Waveform Generator Channels	Digital Channels	Bode Plot
DHO5054	500 MHz	4	-	-	-
DHO5104	1 GHz	4	-	-	-
MHO5054	500 MHz	4	2 ^[1]	16	Supported ^[1]
MHO5104	1 GHz	4	2 ^[1]	16	Supported ^[1]
MHO5056	500 MHz	6	-	16	-
MHO5106	1 GHz	6	-	16	-
DHO5058	500 MHz	8	-	-	-
DHO5108	1 GHz	8	-	-	-

Note: [1] The MHO5000-AWG option is required to be installed for use.

Unless otherwise specified, this manual takes DHO5108 as an example to illustrate the operation methods of MHO/DHO5000 series. The digital analysis, function/ arbitrary waveform generator and Bode plot are illustrated by the MHO5104 model.

3 General Inspection

1. Inspect the packaging

If the packaging has been damaged, do not dispose the damaged packaging or cushioning materials until the shipment has been checked for completeness and has passed both electrical and mechanical tests.

The consigner or carrier shall be liable for the damage to the instrument resulting from shipment. RIGOL would not be responsible for free maintenance/rework or replacement of the instrument.

2. Inspect the instrument

In case of any mechanical damage, missing parts, or failure in passing the electrical and mechanical tests, contact your RIGOL sales representative.

3. Check the accessories

Please check the accessories according to the packing lists. If the accessories are damaged or incomplete, please contact your RIGOL sales representative.

Recommended Calibration Interval

RIGOL suggests that the instrument should be calibrated every 18 months.

4 Product Overview

RIGOL MHO/DHO5000 series is a high-resolution digital oscilloscope designed for the vast mainstream digital oscilloscope market to meet the design, debugging, and test demands. It is developed based on RIGOL's brand new self-developed Centaurus technical platform. Its 4 GSa/s sample rate, 1 GHz real-time bandwidth, 1,000,000 wfms/s waveform capture rate (in fast recording mode), 500 Mpts memory depth, 12-bit resolution, excellent noise floor and vertical measurement accuracy can meet the test demands for higher accuracy. MHO/DHO5000 series digital oscilloscope has multiple models, supporting AFG, digital signal analysis, Bode plot, and other functions. It is powered by battery pack, convenient to operate and control, applicable for various complex test scenarios.

4.1 Appearance and Dimensions

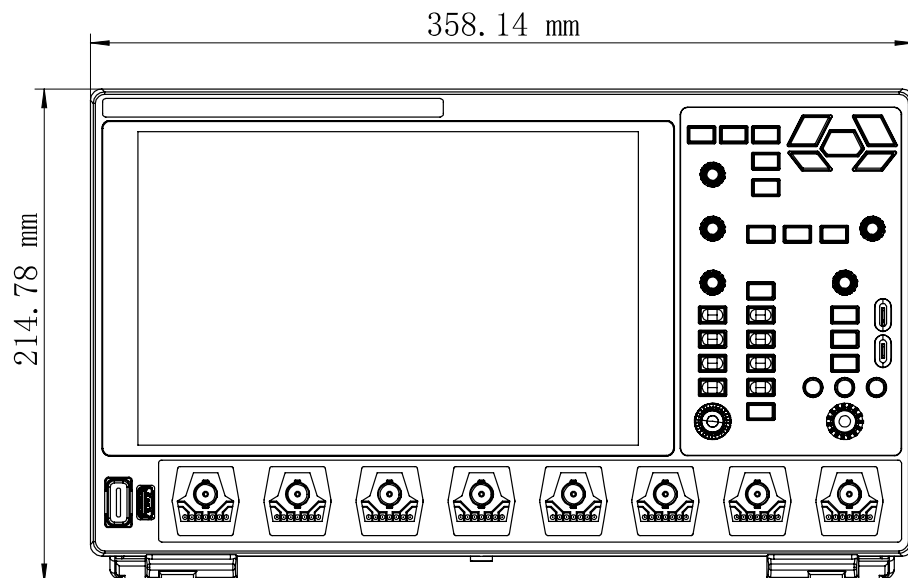

Figure 4.1 Front View

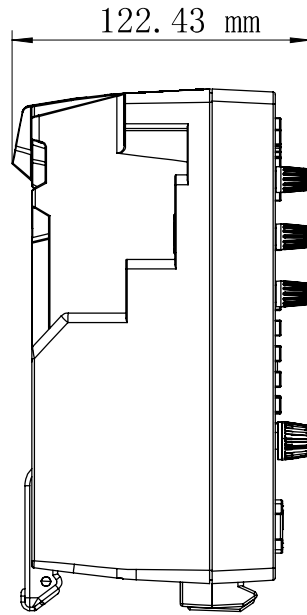

Figure 4.2 Side View

4.2 Front Panel Overview

This chapter takes the MHO5104 model with digital channels and arbitrary waveform generator (AFG) features, and the eight-channel DHO5108 model as examples to introduce the front panel.

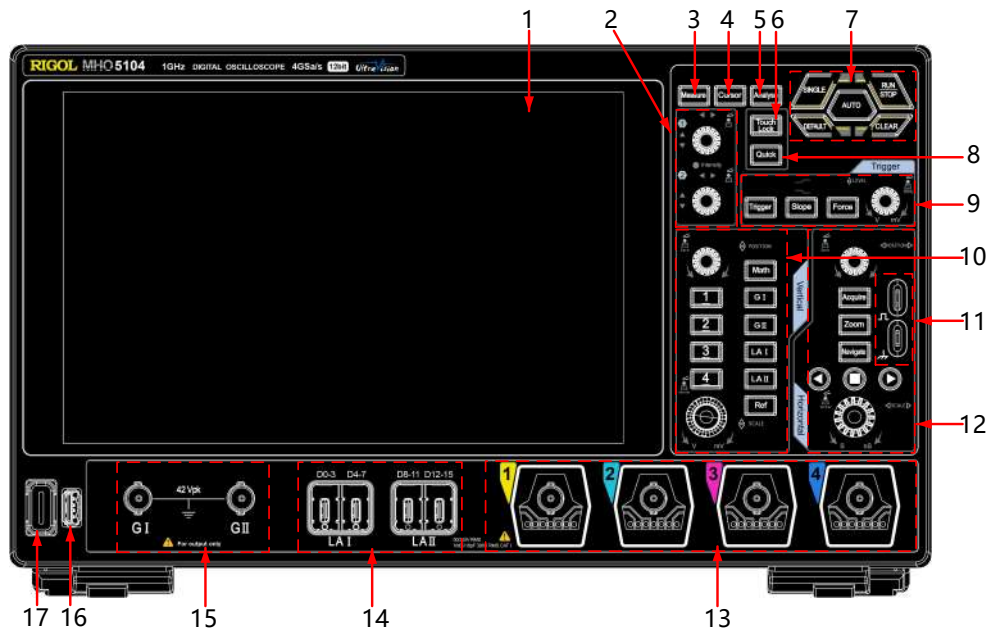

Figure 4.3 Front Panel of MHO5104

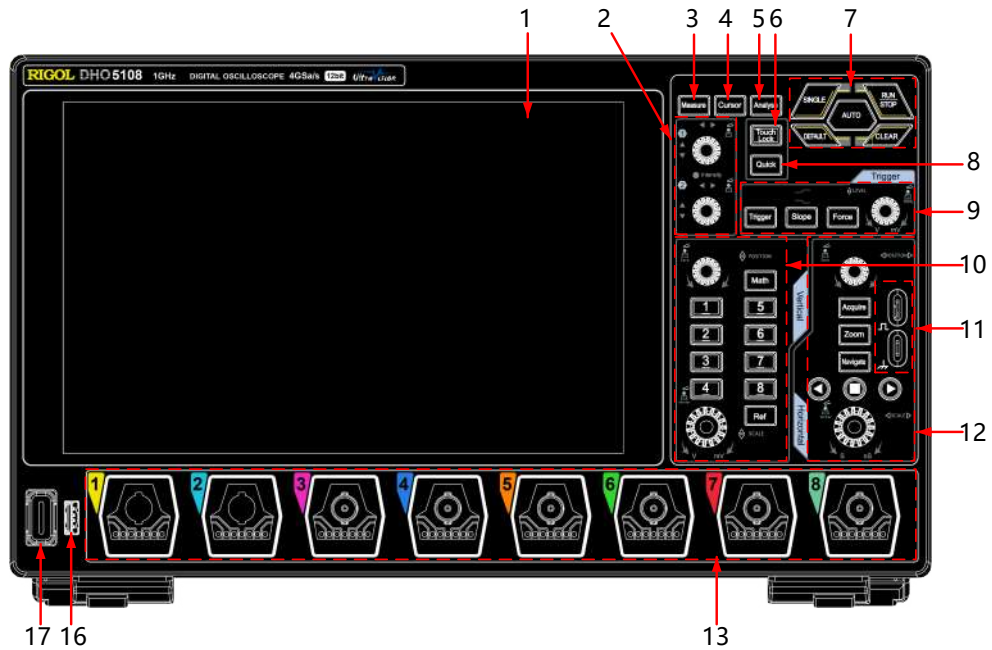

Figure 4.4 Front Panel of DHO5108

1	10.1" Capacitive Touch Screen	10	Vertical Controls
2	Multifunction Knobs	11	Probe Compensation Signal Output Terminal/Ground Terminal
3	Measure Key	12	Horizontal Controls
4	Cursor Key	13	Analog Channel Input Terminals
5	Analyse Key	14	Digital Channel Input (Type-C Interface) ^[1]
6	Touch Lock Key	15	Two-Channel Function/Arbitrary Waveform Generator Output Terminal ^[2]
7	Common Tools Keys	16	USB HOST Port
8	Quick Action Key (Self-defined function)	17	Power Switch
9	Trigger Controls		

NOTE

[1]: Digital channels are only available for MHO5054, MHO5104, MHO5056, and MHO5106 models.

[2]: Arbitrary Waveform/Function Generator (AFG) is only available for MHO5054 and MHO5104 models.



4.3 Rear Panel Overview

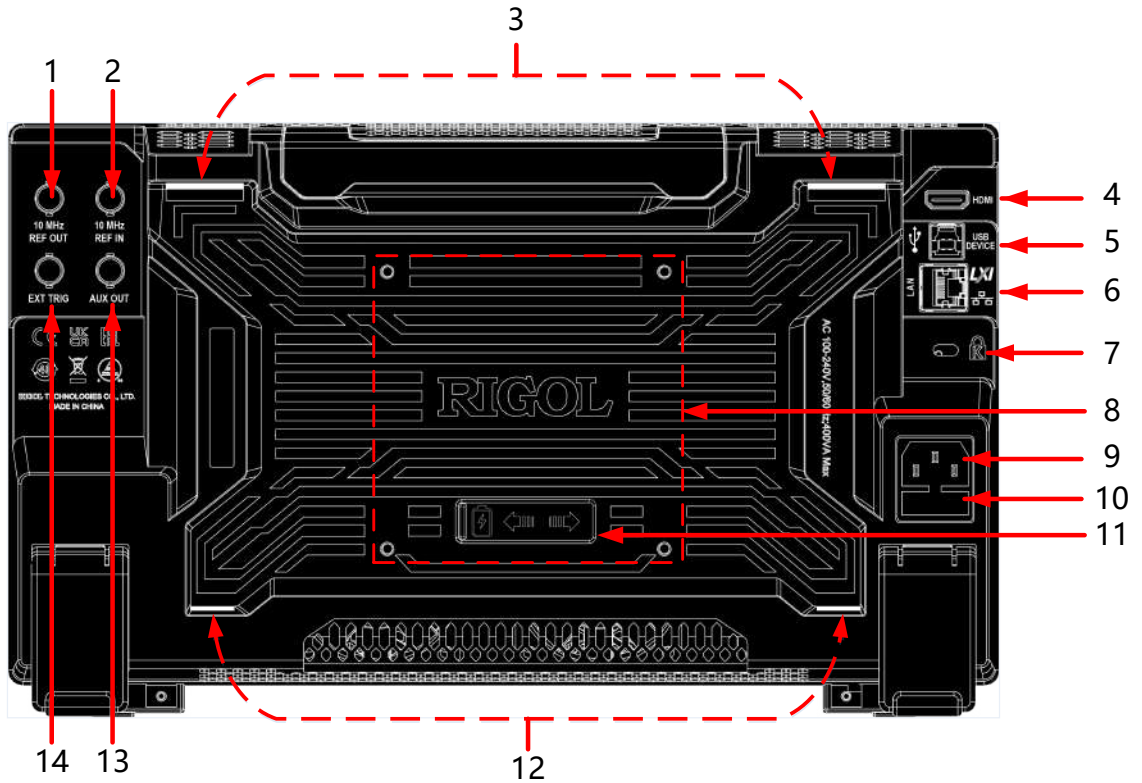

Figure 4.5 Rear Panel

- 1 10 MHz Reference Clock Output Connector
- 2 10 MHz Reference Clock Input Connector
- 3 Battery Pack Snap-Fit Slot
- 4 HDMI Connector
- 5 USB DEVICE Port
- 6 LAN Port
- 7 Security Lock Hole
- 8 Mounting Hole
- 9 AC Power Cord Connector
- 10 Fuse
- 11 Battery Pack Interface
- 12 Battery Pack Mounting Slot
- 13 Trigger Output Connector
- 14 External Trigger Input Connector

4.4 User Interface Overview

This chapter takes the MHO5104 model with digital channels and arbitrary waveform generator (AFG) features, and the eight-channel DHO5108 model as examples to introduce the user interface.

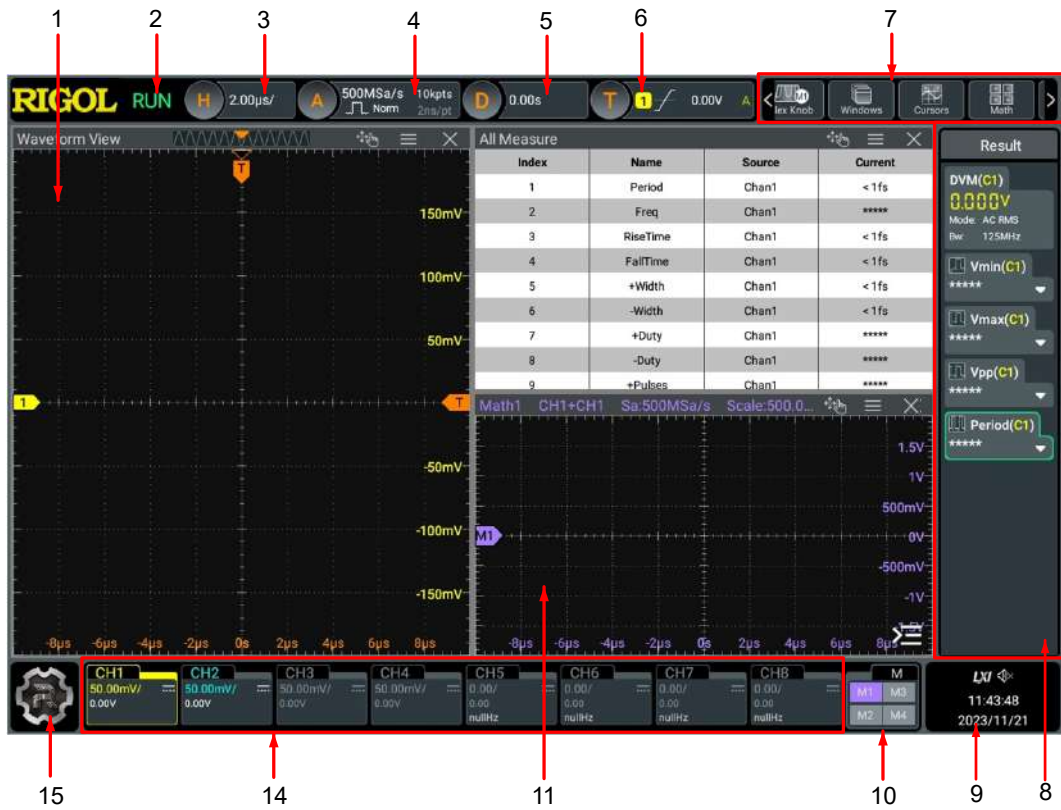

Figure 4.6 User Interface of DHO5108

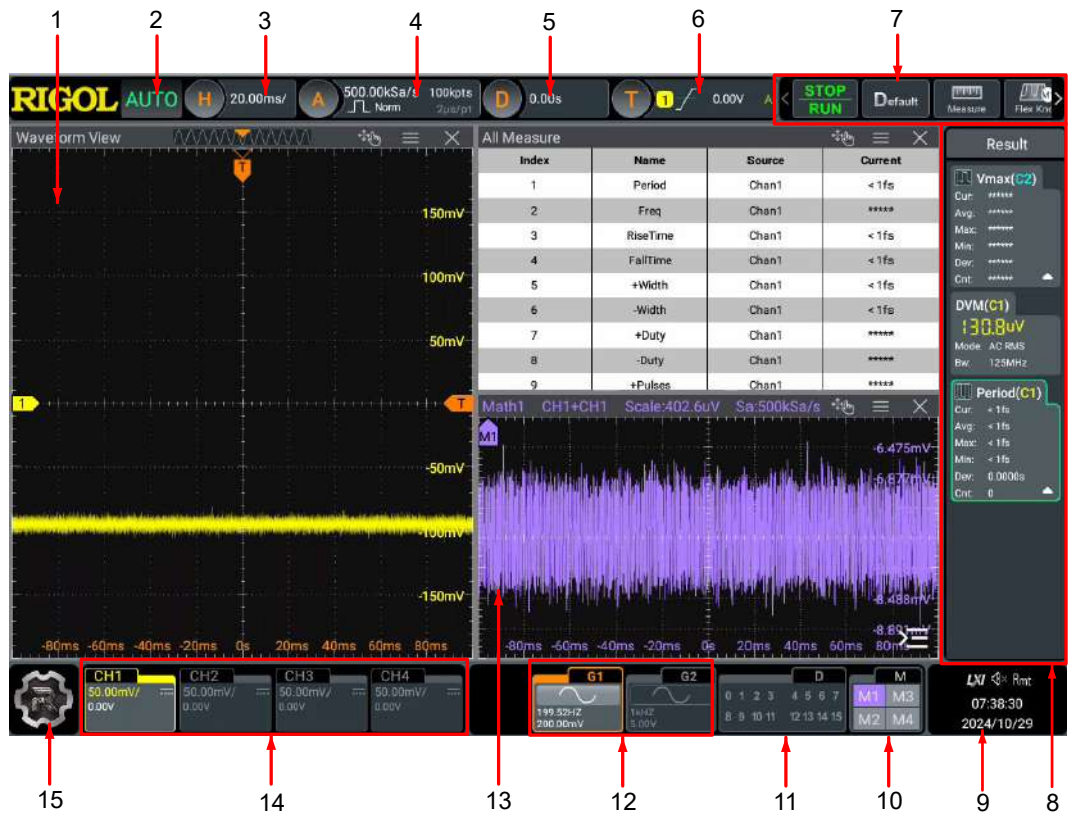

Figure 4.7 User Interface of MHO5104

- | | | | |
|---|----------------------------------|----|---|
| 1 | Waveform View | 9 | Notification Area |
| 2 | Operating Status Label | 10 | Math Labels |
| 3 | Horizontal Timebase Label | 11 | Digital Channel Labels ^[1] |
| 4 | Sample Rate & Memory Depth Label | 12 | Function/Arbitrary Waveform Generator Channels ^[2] |
| 5 | Horizontal Position Label | 13 | Split-screen Display |
| 6 | Trigger Label | 14 | Analog Channel Labels |
| 7 | Function Icon Bar | 15 | Function Navigation Icon |
| 8 | Result List | | |

NOTE

[1]: Digital channels are only available for MHO5054, MHO5104, MHO5056, and MHO5106 models.

[2]: Arbitrary Waveform/Function Generator (AFG) is only available for MHO5054 and MHO5104 models.



5 To Prepare for Use

5.1 To Adjust the Supporting Legs

Adjust the supporting legs properly to use them as stands to tilt the oscilloscope upwards for stable placement of the oscilloscope as well as better operation and observation. You can also fold the supporting legs when the instrument is not in use for easier storage or shipment, as shown in the figure below.

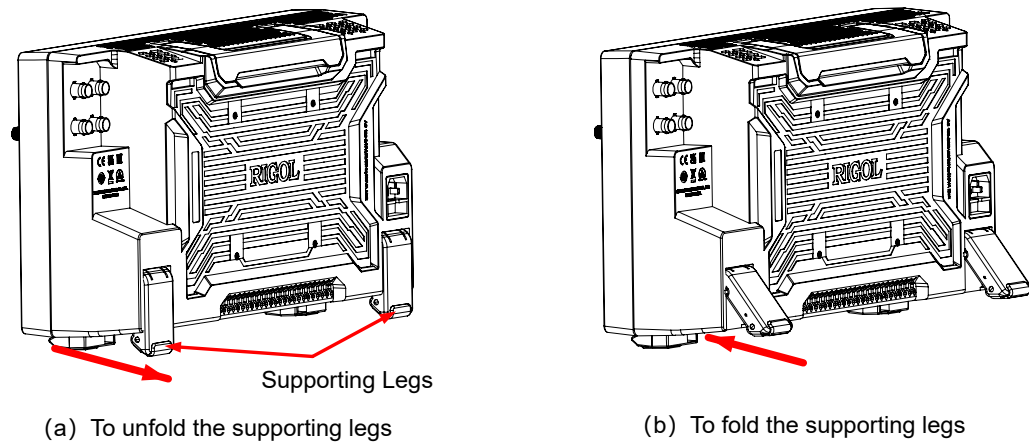
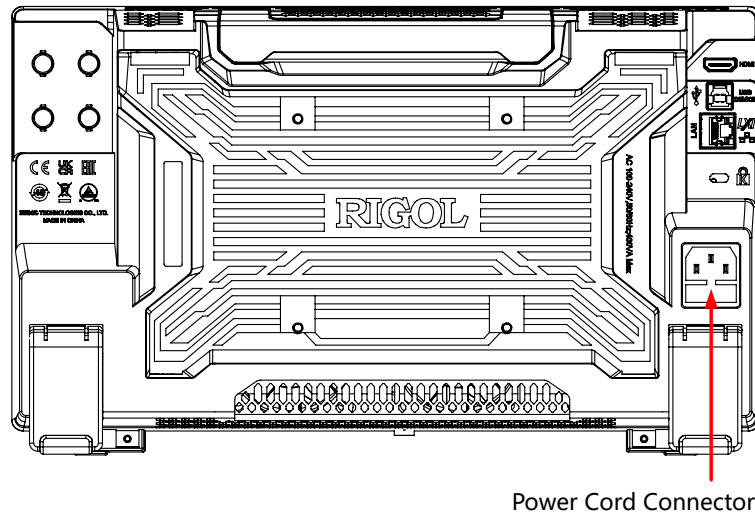

Figure 5.1 Adjust the Supporting Legs

5.2 To Connect to AC Power

The AC power requirements of the oscilloscope are 100-240 V, 50-60 Hz. Please use the power cord provided in the accessories to connect the oscilloscope to the AC power source, as shown in the figure below.



Power Cord Connector

Figure 5.2 Connect to AC Power

**WARNING**





To avoid electric shock, ensure that the instrument is correctly grounded.

**TIP**

If the oscilloscope is equipped with battery pack, the battery will also be powered.

5.3 Turn-on Checkout

After the instrument is connected to the power source, press the power key  at the lower-left corner of the front panel to power on the instrument. During the start-up process, the instrument performs a series of self-tests. After the self-test, the splash screen is displayed.

- **Restart:** Click or tap  > **Restart**. Then a prompt message "Are you sure to reboot?" is displayed. Click or tap **OK** to restart the instrument.
- **Shutdown:**
 - Click or tap  > **Shutdown**. Then a prompt message "Are you sure to shutdown?" is displayed. Click or tap **OK** to shut down the instrument.
 - Press the power key  and a prompt message "Are you sure to shutdown?" is displayed. Click or tap **OK** to shut down the instrument.
 - Press  twice to directly shut down the instrument.

- Press **0** for three seconds to directly shut down the instrument.

**TIP**

You can also click or tap  > **Utility** > **Setup**, then select "Switch On" under the "Power Status" menu. After this setting, the instrument powers on once connected to power.

5.4 To Set the System Language

This oscilloscope supports multiple languages. You can click or tap  > **Utility** > **Setup** > **Language** to select the system language.

5.5 To Connect the Probe

RIGOL provides passive and active probes for MHO/DHO5000 series. For specific probe models, please refer to *MHO/DHO5000 Data Sheet*. For detailed technical information of the probes, please refer to the corresponding Probe User Guide.

Connect the Passive Probe

1. Connect the BNC terminal of the probe to an analog channel input terminal of the oscilloscope on the front panel as shown in the figure below.
2. Connect the ground alligator clip or spring of the probe to the circuit ground terminal, and then connect the probe tip to the circuit point to be tested.

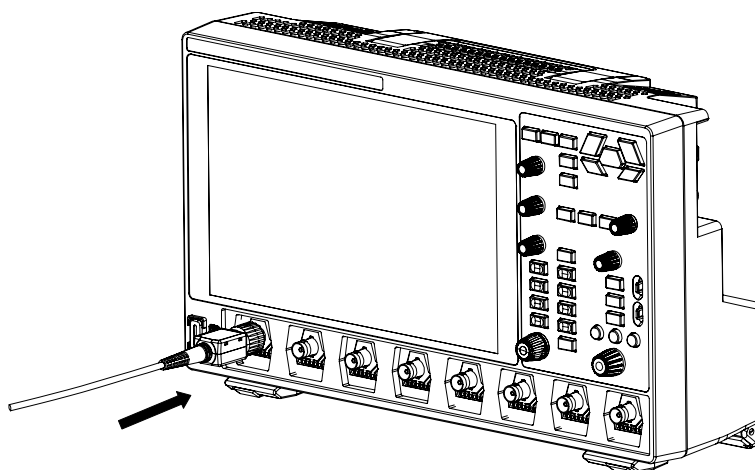

Figure 5.3 Connect the Passive Probe

After you connect the passive probe, check the probe function and probe compensation adjustment before making measurements. For details, please refer to *Function Inspection* and *Probe Compensation*.

Connect the Active Probe

Take PVA7250 (active differential probe) as an example.

1. Connect the probe head to the preamp of the active probe, as shown in the figure below.

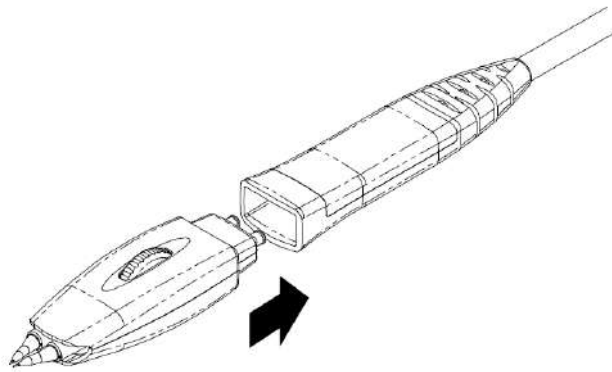

Figure 5.4 Connect the Probe Head to the PA of the Active Probe

2. Connect the other end of the preamp to an analog channel input terminal of the oscilloscope on the front panel, as shown in the figure below. Note that you need to push the probe to the due position to lock it firmly.

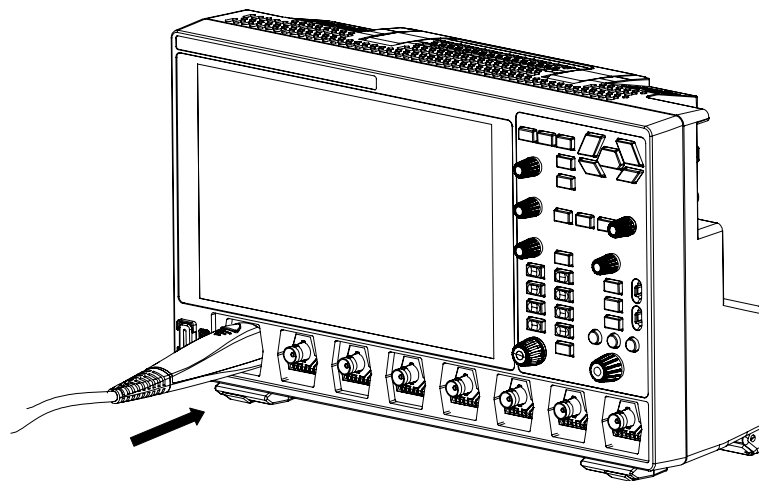

Figure 5.5 Connect the Active Probe

3. Use the probe's auxiliary device to connect the probe head to the circuit under test. For detailed information of the probes, please refer to *User Guide for PVA7000 Series Active Probe*.

After connecting the active probe, you can perform probe calibration and offset voltage adjustment if necessary. For details, refer to descriptions about the active probe in this series User Guide.

Connect the Logic Probe

1. Connect the output terminal of the logic probe to the digital channel input terminal on the front panel of the oscilloscope in the correct direction, as shown in the figure below.
2. Connect the other terminal of the logic probe to the signal terminal under test. MHO/DHO5000 provides the optional PLA3204 active logic probe. For details, refer to *User Guide for PLA3204 Logic Probe*.

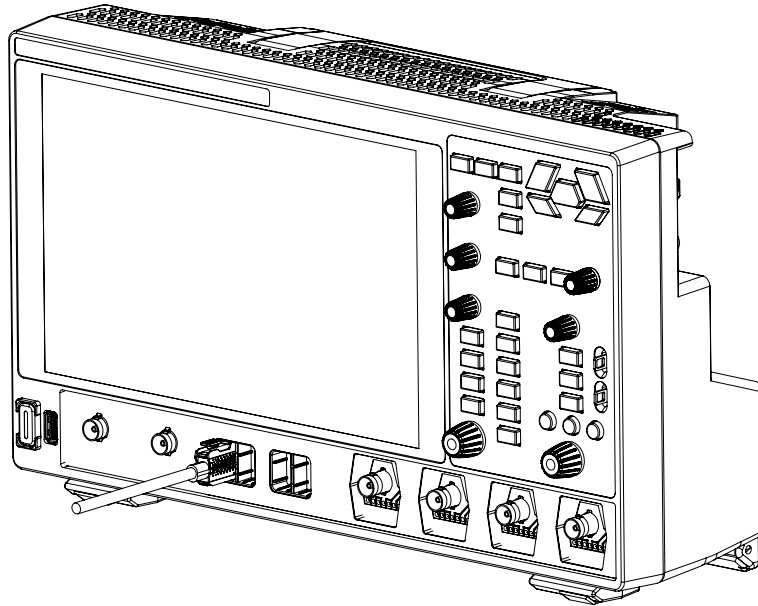



Figure 5.6 Connect the Logic Probe



TIP

- For ground connection of high-speed signals, the ground lead shall be connected to the ground test point near the measured signal, and the ground lead shall be kept as short as possible.
- If there are a large number of input signal channels, please connect each signal to a ground signal as far as possible. If there is only one ground test point, connect all ground leads on the probe to the ground test point.
- Set the threshold value of the logic probe reasonably according to the actual level range of the measured signal, and set the threshold value in the middle of the level range.

5.6 Function Inspection

1. Press the front-panel  and a prompt message "Restore default settings?" is displayed. Click or tap **OK** to restore the instrument to its factory default settings.
2. Connect the ground alligator clip of the probe to the "Ground Terminal" as shown in *Figure 5.7*.

3. Use the probe to connect the input terminal of CH1 and the "Compensation Signal Output Terminal" of the probe, as shown in *Figure 5.7*.

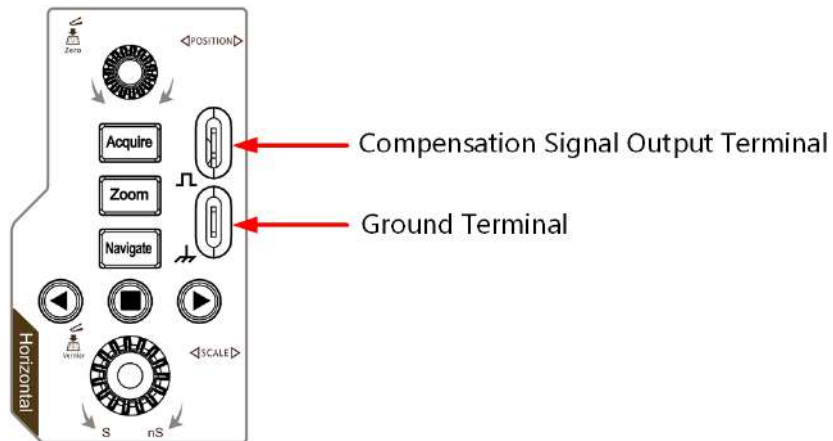



Figure 5.7 Use the Compensation Signal

4. Set the probe ratio based on the attenuation of the probe, and then click or tap  > **Auto**.
5. Observe the waveform on the display. In normal condition, you should see a square waveform as shown in the figure below.

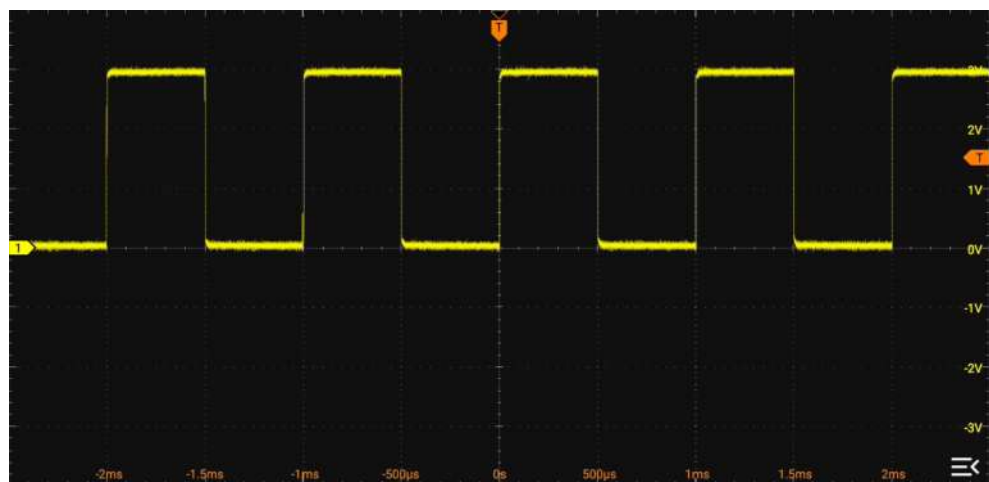

Figure 5.8 Square Waveform Signal

6. Use the same method to test other channels. If the square waveforms actually shown do not match that in the figure above, please perform *Probe Compensation* introduced in the next section. If no waveform is displayed on the screen, perform the above steps again.



WARNING

To avoid electric shock when using the probe, please make sure that the insulated wire of the probe is in good condition. Do not touch the metallic part of the probe when the probe is connected to high voltage source.

5.7 Probe Compensation

When used for the first time, the oscilloscope probe must be compensated to match the input characteristics of the oscilloscope channel to which it is connected. The non-compensated or poorly compensated probe may cause measurement errors. The compensation procedure is as follows:

1. Perform step 1, 2, 3, and 4 in *Function Inspection*.
2. Check the displayed waveforms and compare them with waveforms shown in the figure below.

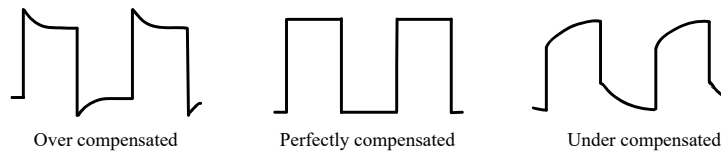

Figure 5.9 Probe Compensation

3. Use the probe compensation adjustment tool provided in the accessories to adjust the low-frequency compensation adjustment hole on the probe until the displayed waveform is consistent with the "Perfectly compensated" waveform shown in the figure above.

6 Touch Screen Gestures

The instrument provides a super large capacitive touch screen, which is convenient for users to operate and make configurations. It has strong waveform display capacity and excellent user experience. It features great convenience, high flexibility, and great sensitivity. The actions supported by the touch screen controls include tapping, pinching&stretching, and dragging.

6.1 Tap

Use one finger to tap the symbol or characters on the screen slightly, as shown in *Figure 6.1*. With the Tap gesture, you can perform the following operations:

- Tap the menu displayed on the screen to operate on the menu.
- Tap the function navigation icon at the lower-left corner of the touch screen to enable the function navigation.
- Tap the displayed numeric keypad to set the parameters.
- Tap the virtual keypad to set the label name and the filename.
- Tap the close button at the upper-right corner of the message box to close the prompt window.
- Tap other windows on the touch screen and operate on the windows.



Figure 6.1 Tap Gesture

6.2 Drag

Use one finger to select the object, and then drag the object to a destination place, as shown in the figure below. With the drag gesture, you can perform the following operation:

- Drag the waveform to change its position or scale.
- Drag the window controls to change the position of the window (e.g. numeric keypad).
- Drag the cursor to move the cursor.
- Drag the trigger cursor to change the trigger level.
- In multi-window display, drag one of the displayed windows to change its position on the display.

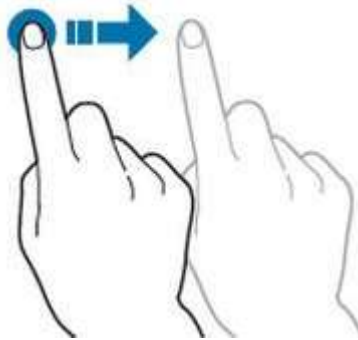

Figure 6.2 Drag Gesture

6.3 Pinch&Stretch

Pinch or stretch two points on the screen with two fingers to zoom in or out the waveform. To zoom in the waveform, first pinch the two fingers and then stretch the fingers; to zoom out the waveform, first stretch the two fingers, and then pinch the fingers together, as shown in the figure below. With the pinch&stretch gesture, you can perform the following operation:

- Pinching&stretching in the horizontal direction can adjust the horizontal time base of the waveform.
- Pinching&stretching in the vertical direction can adjust the vertical scale of the waveform.



Figure 6.3 Pinch&Stretch Gesture

7 To Use the Built-in Help System

The built-in help file provides information about the functions and menu

introductions of the instrument. Click or tap  > **Help** to enter the help system.

In the help system, you can get its help information by clicking on or tapping the link for the specified chapter.

8 Parameter Setting Method

For this instrument, you can use the knob and touch screen to set parameters. The common parameter setting methods are as follows:

- **Method 1:** Some parameters can be adjusted by rotating the knob on the front panel.
- **Method 2:** Click or tap the input field of a specified parameter, then a virtual keypad is displayed. Complete the parameter setting with the keypad.

Input Chinese and English Characters

When naming a label, this instrument supports Chinese/English input method. The following part introduces how to input Chinese and English characters with the Chinese/English input method.

- **Input English Characters**

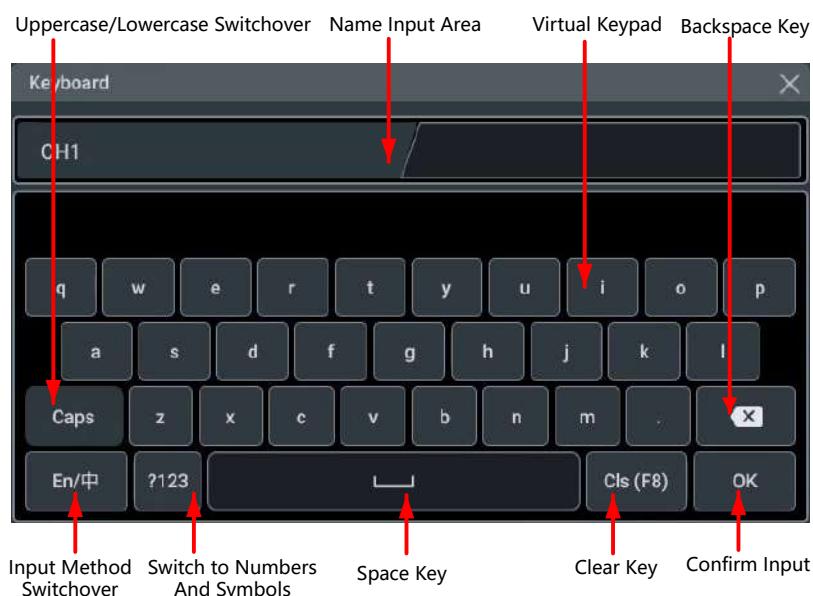

Figure 8.1 English Input Interface

1. Select English input method

First check the input method type. If it shows "En/中", then go to Step 2; if it shows "中/En", click or tap the input method switchover key to switch to "En/中" (English input method).

2. Clear the name input area

If there is no character in the "Name Input Area", please go to the next step. If there are characters in the "Name Input Area", click or tap the Backspace key to delete all the characters from the "Name Input Area" in order.

3. Input the upper-case letter

If you want to input an upper-case letter, first use the Caps key to switch between the upper-case and lower-case mode. If the Caps key is selected, input the upper-case letter with the virtual keypad. If not, first click or tap the Caps key to ensure it is selected, then input the upper-case letter. All the input letters will be displayed in the "Name Input Area".

4. Input the lower-case letter

Refer to the operation specified in the previous step. If the Caps key is not selected, directly input the lower-case letter.

5. Input numbers or symbols

If the letter keypad is displayed, you need to click or tap the numeric switchover key to switch to the numeric keypad, and input numbers or symbols with the numeric keypad. All the input letters will be displayed in the "Name Input Area".

6. Modify or delete the unwanted characters that have been input

During the name input process, you can modify or delete the unwanted character if necessary. To delete the characters that have been input, click or tap the Backspace key in the virtual keypad to delete the characters. To modify the characters that have been input, delete the unwanted characters first and then input the new characters.

You can directly move the cursor to the character to be modified or deleted, delete the desired character or input the new characters after deleting the unwanted character.

7. Confirm the input

After completing the input operation, click or tap "OK".

- **Input Chinese Characters**

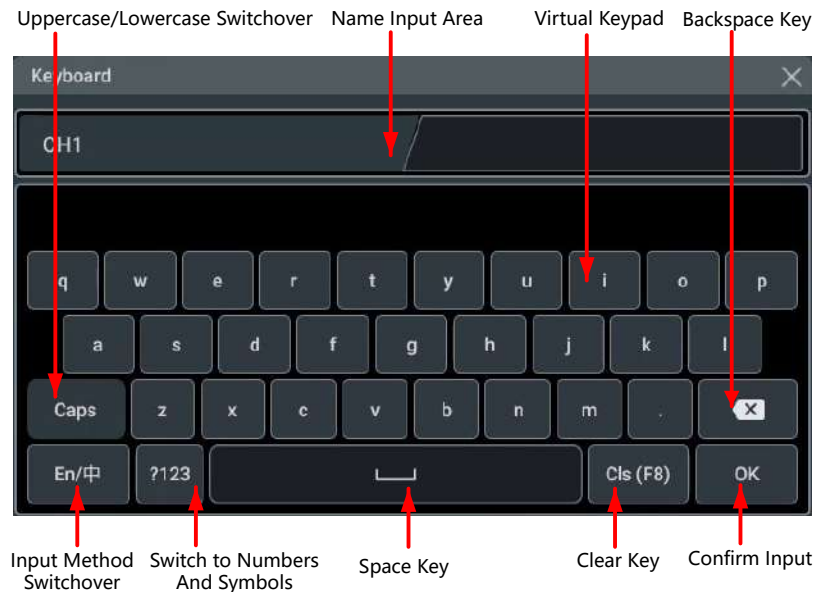

Figure 8.2 Chinese Input Interface

1. Select Chinese input method

2. Clear the name input area

If there are characters in the "Pinyin Input Area", when you delete characters from the name input area, the characters in the Pinyin input area will be deleted first.

3. Input Chinese characters

4. Modify or delete the unwanted characters that have been input

5. Confirm the input

Input a Value

When setting or modifying a parameter, input an appropriate value with the numeric keypad.

- Click or tap the value or unit in the numeric keypad to complete the input.
- Rotate the multifunction knob (1/2) to move the cursor to select the desired value and unit. Press down the knob to confirm the input.

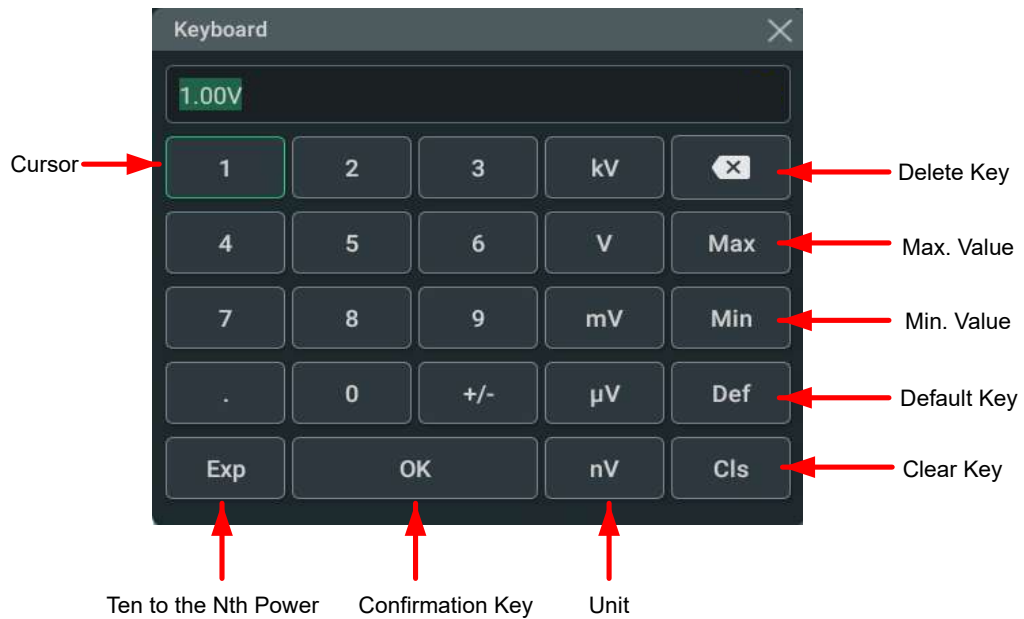

Figure 8.3 Numeric Keypad

After you input all the values and select the desired units, the numeric keypad is turned off automatically. This indicates that you have completed parameter setting. Besides, after you have input the values, you can also click or tap "OK" directly to close the numeric keypad. At this time, the unit of the parameter is the default unit. In the numeric keypad, you can perform the following operations:

- Delete the parameter value that has been input;
- Set the parameter value to a maximum or minimum value;
- Set the parameter to a default value;
- Clear the parameter input field.

9 To Replace the Fuse

If you need to replace the fuse, please use the proper fuse (AC 250 V, T3.15 A; 5.2 mm×20 mm) and follow the steps shown below (see *Figure 9.1*).

1. Power off the instrument and remove the power cord.
2. Insert a small straight screwdriver into the slot at the power socket and pry out the fuse holder gently.
3. Remove the fuse.
4. Insert the proper fuse into the fuse holder.
5. Re-insert the fuse holder into the power socket.

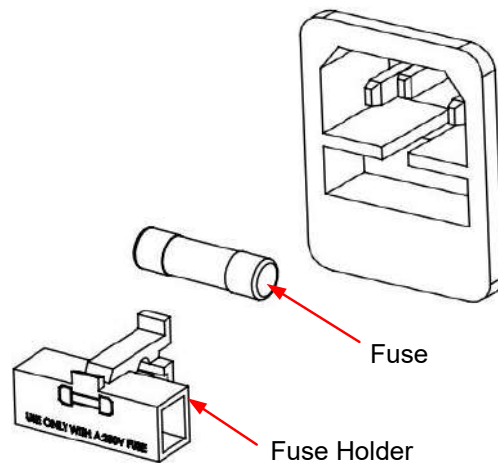

Figure 9.1 Replace the Fuse



WARNING

To avoid electric shock, please make sure that the instrument is powered off and disconnected from the power before replacing the fuse. Also, please make sure the fuse is consistent with the required fuse rating.

10 Remote Control

The following ways of remote control are supported:

- **User-defined Programming**

Users can program and control the instrument by using the SCPI (Standard Commands for Programmable Instruments) commands. For details about the SCPI commands and programming, refer to *Programming Guide* of this product series.

- **PC Software**

You can use the PC software to send SCPI commands to control the instrument remotely. RIGOL Ultra Sigma is recommended. You can download the software from RIGOL official website (<http://www.rigol.com>).

Operation Procedures:

- Set up communication between the instrument and PC.
- Run Ultra Sigma and search for the instrument resource.
- Open the remote command control panel to send commands.

- **Web Control**

This instrument supports Web Control. Connect the instrument to the network, then input the IP address of the instrument into the address bar of the browser of your computer. The web control interface is displayed. Click Web Control to enter the web control page. Then you can view the display of the real-time interface of the instrument. Through the Web Control method, you can migrate the device control to the control terminals (e.g. PC, Mobile, iPad, and other smart terminals) to realize remote control of the instrument. You have to log in before using the Web Control to modify network settings. When you first log in to the Web Control, the user name is "admin" and password is "rigol".

This instrument can be connected to the PC via the USB and LAN interface to set up communication and realize remote control through the PC.



CAUTION

Before connecting the communication cable, please turn off the instrument to avoid causing damage to the communication interfaces.

11 More Product Information

1. Obtain the Device Information

Click or tap  > **Utility** > **About** to obtain the information of the instrument, such as the model, serial number, and hardware version number.

2. View the Option Information and Install the Option

The instrument is installed with the trial versions of the options before leaving factory. The trial time starts from the time when you power on the instrument for the first time, and the trial time is about 2,160 minutes. Open the "Utility" menu, and then click or tap **Option** to view the options currently installed on the oscilloscope and their information. For details, refer to descriptions in User Guide of this series.

For more information about the instrument, refer to the relevant manuals by logging in to the official website of RIGOL (<http://www.rigol.com>) to download them.

- *MHO/DHO5000 User Guide* introduces the functions of the instrument and the operation methods, remote control methods, possible failures and solutions in using the instrument, specifications, and order information.
- *MHO/DHO5000 Programming Guide* provides detailed descriptions of SCPI commands and programming examples of the instrument.
- *MHO/DHO5000 Data Sheet* provides the key features and technical specifications of the instrument.

Boost Smart World and Technology Innovation

Industrial Intelligent
Manufacturing



Semiconductors

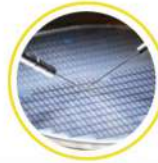

Education &
Research



Communication

System Integration



New Energy



- 5G Cellular-5G/WIFI
- UWB/RFID/ ZIGBEE
- Digital Bus/Ethernet
- Optical Communication

- Digital/Analog/RF Chip
- Memory and MCU Chip
- Third-Generation Semiconductor
- Solar Photovoltaic Cells

- New Energy Automobile
- PV/Inverter
- Power Test
- Automotive Electronics

Provide Testing and Measuring Products
and Solutions for Industry Customers

HEADQUARTER

RIGOL TECHNOLOGIES CO., LTD.
No.8 Keling Road, New District,
Suzhou, JiangSu, P.R.China
Tel: +86-400620002
Email: info@rigol.com

JAPAN

RIGOL JAPAN CO., LTD.
5F, 3-45-6, Minamiotsuka, Toshima-Ku,
Tokyo, 170-0005, Japan
Tel: +81-3-6262-8932
Fax: +81-3-6262-8933
Email: info.jp@rigol.com

EUROPE

RIGOL TECHNOLOGIES EU GmbH
Carl-Benz-Str.11
82205 Gilching
Germany
Tel: +49(0)8105-27292-0
Email: info-europe@rigol.com

KOREA

RIGOL KOREA CO., LTD.
5F, 222, Gonghang-daero,
Gangseo-gu, Seoul, Republic of Korea
Tel: +82-2-6953-4466
Fax: +82-2-6953-4422
Email: info.kr@rigol.com

NORTH AMERICA

RIGOL TECHNOLOGIES, USA INC.
10220 SW Nimbus Ave.
Suite K-7
Portland, OR 97223
Tel: Tel: +1-877-4-**RIGOL**-1
Fax: +1-877-4-**RIGOL**-1
Email: info@rigol.com

RIGOL® is the trademark of **RIGOL TECHNOLOGIES CO., LTD.** Product information in this document is subject to update without notice. For the latest information about **RIGOL's** products, applications and services, please contact local **RIGOL** channel partners or access **RIGOL** official website: www.rigol.com